



Government of the Republic of the Philippines

DAVAO DEL SUR STATE COLLEGE
PHILIPPINE BIDDING DOCUMENTS

**PROCUREMENT OF INFRASTRUCTURE
PROJECTS**

For the

**SUPPLIES, MATERIALS AND LABOR COSTS
FOR THE REFURBISHMENT OF BUILDING
(GMP/HACCP FACILITY) FOR TBI PROJECT
OPERATION**

Sixth Edition
July 2020

Preface

These Philippine Bidding Documents (PBDs) for the procurement of Infrastructure Projects (hereinafter referred to also as the “Works”) through Competitive Bidding have been prepared by the Government of the Philippines for use by all branches, agencies, departments, bureaus, offices, or instrumentalities of the government, including government-owned and/or -controlled corporations, government financial institutions, state universities and colleges, local government units, and autonomous regional government. The procedures and practices presented in this document have been developed through broad experience, and are for mandatory use in projects that are financed in whole or in part by the Government of the Philippines or any foreign government/foreign or international financing institution in accordance with the provisions of the 2016 revised Implementing Rules and Regulations (IRR) of Republic Act (RA) No. 9184.

The PBDs are intended as a model for admeasurements (unit prices or unit rates in a bill of quantities) types of contract, which are the most common in Works contracting.

The Bidding Documents shall clearly and adequately define, among others: (i) the objectives, scope, and expected outputs and/or results of the proposed contract; (ii) the eligibility requirements of Bidders; (iii) the expected contract duration; and (iv) the obligations, duties, and/or functions of the winning Bidder.

Care should be taken to check the relevance of the provisions of the PBDs against the requirements of the specific Works to be procured. If duplication of a subject is inevitable in other sections of the document prepared by the Procuring Entity, care must be exercised to avoid contradictions between clauses dealing with the same matter.

Moreover, each section is prepared with notes intended only as information for the Procuring Entity or the person drafting the Bidding Documents. They shall not be included in the final documents. The following general directions should be observed when using the documents:

- a. All the documents listed in the Table of Contents are normally required for the procurement of Infrastructure Projects. However, they should be adapted as necessary to the circumstances of the particular Project.
- b. Specific details, such as the “*name of the Procuring Entity*” and “*address for bid submission*,” should be furnished in the Instructions to Bidders, Bid Data Sheet, and Special Conditions of Contract. The final documents should contain neither blank spaces nor options.
- c. This Preface and the footnotes or notes in italics included in the Invitation to Bid, BDS, General Conditions of Contract, Special Conditions of Contract, Specifications, Drawings, and Bill of Quantities are not part of the text of the final document, although they contain instructions that the Procuring Entity should strictly follow.
- d. The cover should be modified as required to identify the Bidding Documents as to the names of the Project, Contract, and Procuring Entity, in addition to date of issue.

- e. Modifications for specific Procurement Project details should be provided in the Special Conditions of Contract as amendments to the Conditions of Contract. For easy completion, whenever reference has to be made to specific clauses in the Bid Data Sheet or Special Conditions of Contract, these terms shall be printed in bold typeface on Sections I (Instructions to Bidders) and III (General Conditions of Contract), respectively.
- f. For guidelines on the use of Bidding Forms and the procurement of Foreign-Assisted Projects, these will be covered by a separate issuance of the Government Procurement Policy Board.

TABLE OF CONTENTS

Glossary of Terms, Abbreviations, and Acronyms.....	5
Section I. Invitation to Bid	8
Section II. Instructions to Bidders.....	12
1. Scope of Bid.....	13
2. Funding Information	13
3. Bidding Requirements.....	13
4. Corrupt, Fraudulent, Collusive, Coercive, and Obstructive Practices	14
5. Eligible Bidders.....	14
6. Origin of Associated Goods	14
7. Subcontracts	14
8. Pre-Bid Conference.....	15
9. Clarification and Amendment of Bidding Documents.....	15
10. Documents Comprising the Bid: Eligibility and Technical Components.....	15
11. Documents Comprising the Bid: Financial Component	16
12. Alternative Bids	16
13. Bid Prices	16
14. Bid and Payment Currencies.....	17
15. Bid Security.....	17
16. Sealing and Marking of Bids.....	17
17. Deadline for Submission of Bids	17
18. Opening and Preliminary Examination of Bids	17
19. Detailed Evaluation and Comparison of Bids.....	18
20. Post Qualification.....	18
21. Signing of the Contract	18
Section III. Bid Data Sheet.....	19
Section IV. General Conditions of Contract	22
1. Scope of Contract.....	23
2. Sectional Completion of Works	23
3. Possession of Site.....	23
4. The Contractor’s Obligations.....	23
5. Performance Security	23
6. Site Investigation Reports	24

7.	Warranty.....	24
8.	Liability of the Contractor.....	24
9.	Termination for Other Causes.....	24
10.	Dayworks	24
11.	Program of Work.....	25
12.	Instructions, Inspections and Audits	25
13.	Advance Payment.....	25
14.	Progress Payments	25
15.	Operating and Maintenance Manuals.....	25
Section V. Special Conditions of Contract.....		27
Section VI. Specifications		29
Section VII. Drawings.....		34
Section VIII. Bill of Quantities		44
Section IX. Checklist of Technical and Financial Documents.....		48

Glossary of Terms, Abbreviations, and Acronyms

ABC – Approved Budget for the Contract.

ARCC – Allowable Range of Contract Cost.

BAC – Bids and Awards Committee.

Bid – A signed offer or proposal to undertake a contract submitted by a bidder in response to and in consonance with the requirements of the bidding documents. Also referred to as *Proposal* and *Tender*. (2016 revised IRR, Section 5[c])

Bidder – Refers to a contractor, manufacturer, supplier, distributor and/or consultant who submits a bid in response to the requirements of the Bidding Documents. (2016 revised IRR, Section 5[d])

Bidding Documents – The documents issued by the Procuring Entity as the bases for bids, furnishing all information necessary for a prospective bidder to prepare a bid for the Goods, Infrastructure Projects, and/or Consulting Services required by the Procuring Entity. (2016 revised IRR, Section 5[e])

BIR – Bureau of Internal Revenue.

BSP – Bangko Sentral ng Pilipinas.

CDA – Cooperative Development Authority.

Consulting Services – Refer to services for Infrastructure Projects and other types of projects or activities of the GOP requiring adequate external technical and professional expertise that are beyond the capability and/or capacity of the GOP to undertake such as, but not limited to: (i) advisory and review services; (ii) pre-investment or feasibility studies; (iii) design; (iv) construction supervision; (v) management and related services; and (vi) other technical services or special studies. (2016 revised IRR, Section 5[i])

Contract – Refers to the agreement entered into between the Procuring Entity and the Supplier or Manufacturer or Distributor or Service Provider for procurement of Goods and Services; Contractor for Procurement of Infrastructure Projects; or Consultant or Consulting Firm for Procurement of Consulting Services; as the case may be, as recorded in the Contract Form signed by the parties, including all attachments and appendices thereto and all documents incorporated by reference therein.

Contractor – is a natural or juridical entity whose proposal was accepted by the Procuring Entity and to whom the Contract to execute the Work was awarded. Contractor as used in these Bidding Documents may likewise refer to a supplier, distributor, manufacturer, or consultant.

CPI – Consumer Price Index.

DOLE – Department of Labor and Employment.

DTI – Department of Trade and Industry.

Foreign-funded Procurement or Foreign-Assisted Project – Refers to procurement whose funding source is from a foreign government, foreign or international financing institution as specified in the Treaty or International or Executive Agreement. (2016 revised IRR, Section 5[b]).

GFI – Government Financial Institution.

GOCC – Government-owned and/or –controlled corporation.

Goods – Refer to all items, supplies, materials and general support services, except Consulting Services and Infrastructure Projects, which may be needed in the transaction of public businesses or in the pursuit of any government undertaking, project or activity, whether in the nature of equipment, furniture, stationery, materials for construction, or personal property of any kind, including non-personal or contractual services such as the repair and maintenance of equipment and furniture, as well as trucking, hauling, janitorial, security, and related or analogous services, as well as procurement of materials and supplies provided by the Procuring Entity for such services. The term “related” or “analogous services” shall include, but is not limited to, lease or purchase of office space, media advertisements, health maintenance services, and other services essential to the operation of the Procuring Entity. (2016 revised IRR, Section 5[r])

GOP – Government of the Philippines.

Infrastructure Projects – Include the construction, improvement, rehabilitation, demolition, repair, restoration or maintenance of roads and bridges, railways, airports, seaports, communication facilities, civil works components of information technology projects, irrigation, flood control and drainage, water supply, sanitation, sewerage and solid waste management systems, shore protection, energy/power and electrification facilities, national buildings, school buildings, hospital buildings, and other related construction projects of the government. Also referred to as *civil works or works*. (2016 revised IRR, Section 5[u])

LGUs – Local Government Units.

NFCC – Net Financial Contracting Capacity.

NGA – National Government Agency.

PCAB – Philippine Contractors Accreditation Board.

PhilGEPS - Philippine Government Electronic Procurement System.

Procurement Project – refers to a specific or identified procurement covering goods, infrastructure project or consulting services. A Procurement Project shall be described, detailed, and scheduled in the Project Procurement Management Plan prepared by the agency which shall be consolidated in the procuring entity's Annual Procurement Plan. (GPPB Circular No. 06-2019 dated 17 July 2019)

PSA – Philippine Statistics Authority.

SEC – Securities and Exchange Commission.

SLCC – Single Largest Completed Contract.

UN – United Nations.

Section I. Invitation to Bid

Notes on the Invitation to Bid

The Invitation to Bid (IB) provides information that enables potential Bidders to decide whether to participate in the procurement at hand. The IB shall be posted in accordance with Section 21.2 of the 2016 revised IRR of RA No. 9184.

Apart from the essential items listed in the Bidding Documents, the IB should also indicate the following:

- a. The date of availability of the Bidding Documents, which shall be from the time the IB is first advertised/posted until the deadline for the submission and receipt of bids;
- b. The place where the Bidding Documents may be acquired or the website where it may be downloaded;
- c. The deadline for the submission and receipt of bids; and
- d. Any important bid evaluation criteria.

The IB should be incorporated into the Bidding Documents. The information contained in the IB must conform to the Bidding Documents and in particular to the relevant information in the Bid Data Sheet.



Invitation to Bid for Supplies, Materials and Labor Costs for the Refurbishment of Building (GMP/HACCP Facility) for TBI project operation

1. The **Davao del Sur State College**, through the **Fund 163E 2024** intends to apply the sum being the Approved Budget for the Contract (ABC) to payments under the contract for each lot:

Lot no.	Project Identification No.	Title	Qty	Delivery of the Goods	ABC	Bidding Documents Fee
1	DSSCPSU 2024-05-08-A	Supplies and Materials for the Refurbishment of Building (GMP/HACCP Facility)	1 Lot	120 CD upon receipt of Notice to Proceed	Php 1,363,085.00	Php 5,000.00
2	DSSCPSU 2024-05-08-B	Labor Costs for the Refurbishment of Building (GMP/HACCP Facility)	1 Lot	150 CD upon receipt of Notice to Proceed	Php 636,915.00	Php 1,000.00

Bids received in excess of the ABC for each lot shall be automatically rejected at bid opening.

2. The **Davao del Sur State College** now invites bids for the above Procurement Project. Bidders should have completed a contract similar to the Project. The description of an eligible bidder is contained in the Bidding Documents, particularly, in Section II (Instructions to Bidders).
3. Bidding will be conducted through open competitive bidding procedures using non-discretionary “*pass/fail*” criterion as specified in the 2016 revised Implementing Rules and Regulations (IRR) of Republic Act (RA) No. 9184.
4. Interested bidders may obtain further information from **Davao del Sur State College** and inspect the Bidding Documents at the address given below from **08:00 A.M to 05:00 P.M (Monday to Friday)** except holidays.
5. A complete set of Bidding Documents may be acquired by interested bidders on **May 13 to June 05, 2024** from given address and website/s below *and upon payment of the applicable fee for the Bidding Documents, pursuant to the latest Guidelines issued by the GPPB*. The Procuring Entity shall allow the bidder to present its proof of payment for the fees either in person or through e-mail.

It may also be downloaded free of charge from the website of the Philippine Government Electronic Procurement System (PhilGEPS) and the website of the Procuring Entity, provided that bidders shall pay the applicable fee for the Bidding Documents not later than the submission of their bids.

Bidders shall pay the applicable fee for the Bidding Documents not later than the submission of their bids in any of the following payments options:

- Over-the-counter payment at DSSC-Cashier's office, Brgy. Matti, Digos City, Davao del Sur;
- Over-the-counter deposit at Land Bank of the Philippines (LBP) Account No. – 0332-1103-57.

Prior to payment, bidders are advised to coordinate first with the BAC Secretariat through mobile phone at (+63)951 822 5510 for the issuance of the "Payment Order" and instructions.

6. The **Davao del Sur State College** will hold a Pre-Bid Conference¹ on **May 22, 2024; 01:00 P.M.** at **Davao del Sur State College, Brgy. Matti, Digos City, Davao del Sur** and/or through videoconferencing/webcasting *via Zoom*, which shall be open to prospective bidders.
7. Bids must be duly received by the BAC Secretariat through manual submission at the office address as indicated below on or before **June 05, 2024; 01:00 P.M.** Late bids shall not be accepted.
8. All bids must be accompanied by a bid security in any of the acceptable forms and in the amount stated in **ITB** Clause 16.
9. Bid opening shall be on **June 05, 2024; 01:00 P.M** at the given address below. Bids will be opened in the presence of the bidders' representatives who choose to attend the activity.
10. The **Davao del Sur State College** reserves the right to reject any and all bids, declare a failure of bidding, or not award the contract at any time prior to contract award in accordance with Sections 35.6 and 41 of the 2016 revised Implementing Rules and Regulations (IRR) of RA No. 9184, without thereby incurring any liability to the affected bidder or bidders.
11. For further information, please refer to:

RACHEL R. YONTING, LPT
PSU Head/BAC Secretariat
DSSC, Brgy. Matti, Digos City, Davao del Sur
Mobile No. 09518225510
E-mail Address: **psu@dssc.edu.ph**

¹ May be deleted in case the ABC is less than One Million Pesos (PhP1,000,000) where the Procuring Entity may not hold a pre-bid conference.

Website: <https://www.dssc.edu.ph/>

12. You may visit the following websites:

For downloading of Bidding Documents:

<https://www.dssc.edu.ph/administration/procurement/bac-posting>

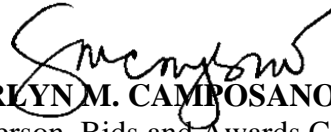

SIVERLYN M. CAMPOSANO, Ph.D.
Chairperson, Bids and Awards Committee

Section II. Instructions to Bidders

Notes on the Instructions to Bidders

This Section on the Instruction to Bidders (ITB) provides the information necessary for bidders to prepare responsive bids, in accordance with the requirements of the Procuring Entity. It also provides information on bid submission, eligibility check, opening and evaluation of bids, post-qualification, and on the award of contract.

1. Scope of Bid

The Procuring Entity, **Davao del Sur State College** wishes to receive Bids for the following:

Lot no.	Project Identification No.	Title	Qty
1	DSSCPSU 2024-05-08-A	Supplies and Materials for the Refurbishment of Building (GMP/HACCP Facility)	1 Lot
2	DSSCPSU 2024-05-08-B	Labor Costs for the Refurbishment of Building (GMP/HACCP Facility)	1 Lot

The Procurement Project (referred to herein as “Project”) is for the construction of Works, as described in Section VI (Specifications).

2. Funding Information

2.1. The GOP through the source of funding as indicated below for **FY 2024** in the amount shown below:

Lot no.	Project Identification No.	Title	Qty	ABC
1	DSSCPSU 2024-05-08-A	Supplies and Materials for the Refurbishment of Building (GMP/HACCP Facility)	1 Lot	Php 1,363,085.00
2	DSSCPSU 2024-05-08-B	Labor Costs for the Refurbishment of Building (GMP/HACCP Facility)	1 Lot	Php 636,915.00

2.2. The source of funding is:

- a. Trust Receipts

3. Bidding Requirements

The Bidding for the Project shall be governed by all the provisions of RA No. 9184 and its 2016 revised IRR, including its Generic Procurement Manual and associated policies, rules and regulations as the primary source thereof, while the herein clauses shall serve as the secondary source thereof.

Any amendments made to the IRR and other GPPB issuances shall be applicable only to the ongoing posting, advertisement, or invitation to bid by the BAC through the issuance of a supplemental or bid bulletin.

The Bidder, by the act of submitting its Bid, shall be deemed to have inspected the site, determined the general characteristics of the contracted Works and the conditions for this Project, such as the location and the nature of the work; (b) climatic conditions; (c) transportation facilities; (c) nature and condition of the terrain, geological conditions at the site communication facilities, requirements, location and availability of construction aggregates and other materials, labor, water, electric power and access roads; and (d) other factors that may affect the cost, duration and execution or implementation of the contract, project, or work and examine all instructions, forms, terms, and project requirements in the Bidding Documents.

4. Corrupt, Fraudulent, Collusive, Coercive, and Obstructive Practices

The Procuring Entity, as well as the Bidders and Contractors, shall observe the highest standard of ethics during the procurement and execution of the contract. They or through an agent shall not engage in corrupt, fraudulent, collusive, coercive, and obstructive practices defined under Annex “I” of the 2016 revised IRR of RA No. 9184 or other integrity violations in competing for the Project.

5. Eligible Bidders

5.1. Only Bids of Bidders found to be legally, technically, and financially capable will be evaluated.

5.2. The Bidder must have an experience of having completed a Single Largest Completed Contract (SLCC) that is similar to this Project, equivalent to at least fifty percent (50%) of the ABC adjusted, if necessary, by the Bidder to current prices using the PSA’s CPI, except under conditions provided for in Section 23.4.2.4 of the 2016 revised IRR of RA No. 9184.

A contract is considered to be “similar” to the contract to be bid if it has the major categories of work stated in the **BDS**.

5.3. For Foreign-funded Procurement, the Procuring Entity and the foreign government/foreign or international financing institution may agree on another track record requirement, as specified in the Bidding Document prepared for this purpose.

5.4. The Bidders shall comply with the eligibility criteria under Section 23.4.2 of the 2016 IRR of RA No. 9184.

6. Origin of Associated Goods

There is no restriction on the origin of Goods other than those prohibited by a decision of the UN Security Council taken under Chapter VII of the Charter of the UN.

7. Subcontracts

- 7.1. The Bidder may subcontract portions of the Project to the extent allowed by the Procuring Entity as stated herein, but in no case more than fifty percent (50%) of the Project.

The Procuring Entity has prescribed that:

- a. Subcontracting is not allowed.
- 7.1. *[If Procuring Entity has determined that subcontracting is allowed during the bidding , state:]* The Bidder must submit together with its Bid the documentary requirements of the subcontractor(s) complying with the eligibility criterial stated in **ITB** Clause 5 in accordance with Section 23.4 of the 2016 revised IRR of RA No. 9184 pursuant to Section 23.1 thereof.
 - 7.2. *[If subcontracting is allowed during the contract implementation stage, state:]* The Supplier may identify its subcontractor during the contract implementation stage. Subcontractors identified during the bidding may be changed during the implementation of this Contract. Subcontractors must submit the documentary requirements under Section 23.1 of the 2016 revised IRR of RA No. 9184 and comply with the eligibility criteria specified in **ITB** Clause 5 to the implementing or end-user unit.
 - 7.3. Subcontracting of any portion of the Project does not relieve the Contractor of any liability or obligation under the Contract. The Supplier will be responsible for the acts, defaults, and negligence of any subcontractor, its agents, servants, or workmen as fully as if these were the Contractor's own acts, defaults, or negligence, or those of its agents, servants, or workmen.

8. Pre-Bid Conference

The Procuring Entity will hold a pre-bid conference for this Project on the specified date and time and either at its physical address and/or through videoconferencing/webcasting} as indicated in paragraph 6 of the **IB**.

9. Clarification and Amendment of Bidding Documents

Prospective bidders may request for clarification on and/or interpretation of any part of the Bidding Documents. Such requests must be in writing and received by the Procuring Entity, either at its given address or through electronic mail indicated in the **IB**, at least ten (10) calendar days before the deadline set for the submission and receipt of Bids.

10. Documents Comprising the Bid: Eligibility and Technical Components

- 10.1. The first envelope shall contain the eligibility and technical documents of the Bid as specified in **Section IX. Checklist of Technical and Financial Documents**.

- 10.2. If the eligibility requirements or statements, the bids, and all other documents for submission to the BAC are in foreign language other than English, it must be accompanied by a translation in English, which shall be authenticated by the appropriate Philippine foreign service establishment, post, or the equivalent office having jurisdiction over the foreign bidder's affairs in the Philippines. For Contracting Parties to the Apostille Convention, only the translated documents shall be authenticated through an apostille pursuant to GPPB Resolution No. 13-2019 dated 23 May 2019. The English translation shall govern, for purposes of interpretation of the bid.
- 10.3. A valid special PCAB License in case of Joint Ventures, and registration for the type and cost of the contract for this Project. Any additional type of Contractor license or permit shall be indicated in the **BDS**.
- 10.4. A List of Contractor's key personnel (e.g., Project Manager, Project Engineers, Materials Engineers, and Foremen) assigned to the contract to be bid, with their complete qualification and experience data shall be provided. These key personnel must meet the required minimum years of experience set in the **BDS**.
- 10.5. A List of Contractor's major equipment units, which are owned, leased, and/or under purchase agreements, supported by proof of ownership, certification of availability of equipment from the equipment lessor/vendor for the duration of the project, as the case may be, must meet the minimum requirements for the contract set in the **BDS**.

11. Documents Comprising the Bid: Financial Component

- 11.1. The second bid envelope shall contain the financial documents for the Bid as specified in **Section IX. Checklist of Technical and Financial Documents**.
- 11.2. Any bid exceeding the ABC indicated in paragraph 1 of the **IB** shall not be accepted.
- 11.3. For Foreign-funded procurement, a ceiling may be applied to bid prices provided the conditions are met under Section 31.2 of the 2016 revised IRR of RA No. 9184.

12. Alternative Bids

Bidders shall submit offers that comply with the requirements of the Bidding Documents, including the basic technical design as indicated in the drawings and specifications. Unless there is a value engineering clause in the **BDS**, alternative Bids shall not be accepted.

13. Bid Prices

All bid prices for the given scope of work in the Project as awarded shall be considered as fixed prices, and therefore not subject to price escalation during contract implementation, except under extraordinary circumstances as determined by the NEDA

and approved by the GPPB pursuant to the revised Guidelines for Contract Price Escalation guidelines.

14. Bid and Payment Currencies

14.1. Bid prices may be quoted in the local currency or tradeable currency accepted by the BSP at the discretion of the Bidder. However, for purposes of bid evaluation, Bids denominated in foreign currencies shall be converted to Philippine currency based on the exchange rate as published in the BSP reference rate bulletin on the day of the bid opening.

14.2. *Payment of the contract price shall be made in:*

- a. Philippine Pesos.

15. Bid Security

15.1. The Bidder shall submit a Bid Securing Declaration or any form of Bid Security in the amount indicated in the **BDS**, which shall be not less than the percentage of the ABC in accordance with the schedule in the **BDS**.

15.2. The Bid and bid security shall be valid until [*indicate date*]. Any bid not accompanied by an acceptable bid security shall be rejected by the Procuring Entity as non-responsive.

16. Sealing and Marking of Bids

Each Bidder shall submit one copy of the first and second components of its Bid.

The Procuring Entity may request additional hard copies and/or electronic copies of the Bid. However, failure of the Bidders to comply with the said request shall not be a ground for disqualification.

If the Procuring Entity allows the submission of bids through online submission to the given website or any other electronic means, the Bidder shall submit an electronic copy of its Bid, which must be digitally signed. An electronic copy that cannot be opened or is corrupted shall be considered non-responsive and, thus, automatically disqualified.

17. Deadline for Submission of Bids

The Bidders shall submit on the specified date and time and either at its physical address or through online submission as indicated in paragraph 7 of the **IB**.

18. Opening and Preliminary Examination of Bids

18.1. The BAC shall open the Bids in public at the time, on the date, and at the place specified in paragraph 9 of the **IB**. The Bidders' representatives who are present shall sign a register evidencing their attendance. In case videoconferencing,

webcasting or other similar technologies will be used, attendance of participants shall likewise be recorded by the BAC Secretariat.

In case the Bids cannot be opened as scheduled due to justifiable reasons, the rescheduling requirements under Section 29 of the 2016 revised IRR of RA No. 9184 shall prevail.

- 18.2. The preliminary examination of Bids shall be governed by Section 30 of the 2016 revised IRR of RA No. 9184.

19. Detailed Evaluation and Comparison of Bids

- 19.1. The Procuring Entity's BAC shall immediately conduct a detailed evaluation of all Bids rated "*passed*" using non-discretionary pass/fail criteria. The BAC shall consider the conditions in the evaluation of Bids under Section 32.2 of 2016 revised IRR of RA No. 9184.
- 19.2. If the Project allows partial bids, all Bids and combinations of Bids as indicated in the **BDS** shall be received by the same deadline and opened and evaluated simultaneously so as to determine the Bid or combination of Bids offering the lowest calculated cost to the Procuring Entity. Bid Security as required by **ITB** Clause 15 shall be submitted for each contract (lot) separately.
- 19.3. In all cases, the NFCC computation pursuant to Section 23.4.2.6 of the 2016 revised IRR of RA No. 9184 must be sufficient for the total of the ABCs for all the lots participated in by the prospective Bidder.

20. Post Qualification

Within a non-extendible period of five (5) calendar days from receipt by the Bidder of the notice from the BAC that it submitted the Lowest Calculated Bid, the Bidder shall submit its latest income and business tax returns filed and paid through the BIR Electronic Filing and Payment System (eFPS), and other appropriate licenses and permits required by law and stated in the **BDS**.

21. Signing of the Contract

The documents required in Section 37.2 of the 2016 revised IRR of RA No. 9184 shall form part of the Contract. Additional Contract documents are indicated in the **BDS**.

Section III. Bid Data Sheet

Notes on the Bid Data Sheet (BDS)

The Bid Data Sheet (BDS) consists of provisions that supplement, amend, or specify in detail, information, or requirements included in the ITB found in Section II, which are specific to each procurement.

This Section is intended to assist the Procuring Entity in providing the specific information in relation to corresponding clauses in the ITB and has to be prepared for each specific procurement.

The Procuring Entity should specify in the BDS information and requirements specific to the circumstances of the Procuring Entity, the processing of the procurement, and the bid evaluation criteria that will apply to the Bids. In preparing the BDS, the following aspects should be checked:

- a. Information that specifies and complements provisions of the ITB must be incorporated.
- b. Amendments and/or supplements, if any, to provisions of the ITB as necessitated by the circumstances of the specific procurement, must also be incorporated.

Bid Data Sheet

ITB Clause																					
5.2	<p>For this purpose, contracts similar to the Project refer to contracts which have the same major categories of work, which shall be:</p> <p>Refurbishment of Building (GMP/HACCP Compliant)</p>																				
7.1	Subcontracting is not allowed.																				
10.3	Prospective Bidder should possess a valid PCAB license. Minimum category requirement for this Project is license category C & D or size range small B																				
10.4	<p>The key personnel must meet the required minimum years of experience set below:</p> <ul style="list-style-type: none"> – Project Engineer Shall be a Licensed Civil/Architect with sufficient knowledge and background in architectural works and structural works, w/ atleast two (2) years of experience in similar projects. – Electrical Engineer The Electrical Engineer must be a registered Electrical Engineer with at least two (2) years in lighting, power distribution and preferably knowledgeable in developments in emergent efficient lighting technologies and energy management. – Safety Officer The safety officer must be an accredited safety practitioner by the Department of Labor and Employment (DOLE) and has undergone the prescribed 40-hour Construction Safety and Health Training (COSH). – Master Plumber The Master Plumber must be a registered Master Plumber with at least two (2) years of experience. 																				
10.5	<p>The minimum major equipment requirements are the following:</p> <table border="1" style="width: 100%; border-collapse: collapse; margin-top: 10px;"> <thead> <tr> <th style="text-align: center;">EQUIPMENT</th> <th style="text-align: center;">NO. OF UNITS (of at least)</th> </tr> </thead> <tbody> <tr> <td>One Bagger Cement Mixer</td> <td style="text-align: center;">1</td> </tr> <tr> <td>Welding Machine</td> <td style="text-align: center;">2</td> </tr> <tr> <td>Bar Cutter</td> <td style="text-align: center;">1</td> </tr> <tr> <td>Bar Bender</td> <td style="text-align: center;">1</td> </tr> <tr> <td>Electric Hand Drill</td> <td style="text-align: center;">1</td> </tr> <tr> <td>Backhoe</td> <td style="text-align: center;">1</td> </tr> <tr> <td>Dump Truck</td> <td style="text-align: center;">1</td> </tr> <tr> <td>Plate Compactor</td> <td style="text-align: center;">1</td> </tr> <tr> <td>Portable Grinder</td> <td style="text-align: center;">1</td> </tr> </tbody> </table>	EQUIPMENT	NO. OF UNITS (of at least)	One Bagger Cement Mixer	1	Welding Machine	2	Bar Cutter	1	Bar Bender	1	Electric Hand Drill	1	Backhoe	1	Dump Truck	1	Plate Compactor	1	Portable Grinder	1
EQUIPMENT	NO. OF UNITS (of at least)																				
One Bagger Cement Mixer	1																				
Welding Machine	2																				
Bar Cutter	1																				
Bar Bender	1																				
Electric Hand Drill	1																				
Backhoe	1																				
Dump Truck	1																				
Plate Compactor	1																				
Portable Grinder	1																				

12	Alternative bid is not allowed		
15.1	The bid security shall be in the form of a Bid Securing Declaration or any of the following forms and amounts:		
	Lot No.	Title	if bid security is in cash, cashier's/manager's check, bank draft/guarantee or irrevocable letter of credit
	1	Supplies and Materials for the Refurbishment of Building (GMP/HACCP Facility)	Php 27,261.70
	2	Labor Costs for the Refurbishment of Building (GMP/HACCP Facility)	Php 12,738.30
19.2	Partial bids are not allowed		
20	Bidders must submit latest and updated tax returns filed through the Electronic Filing and Payments System (EFPS).		
21	Additional contract documents relevant to the Project that may be required by existing laws and/or the Procuring Entity, such as construction schedule and S-curve, manpower schedule, construction methods, equipment utilization schedule, construction safety and health program approved by the DOLE, and other acceptable tools of project scheduling.		

Section IV. General Conditions of Contract

Notes on the General Conditions of Contract

The General Conditions of Contract (GCC) in this Section, read in conjunction with the Special Conditions of Contract in Section V and other documents listed therein, should be a complete document expressing all the rights and obligations of the parties.

Matters governing performance of the Contractor, payments under the contract, or matters affecting the risks, rights, and obligations of the parties under the contract are included in the GCC and Special Conditions of Contract.

Any complementary information, which may be needed, shall be introduced only through the Special Conditions of Contract.

1. **Scope of Contract**

This Contract shall include all such items, although not specifically mentioned, that can be reasonably inferred as being required for its completion as if such items were expressly mentioned herein. All the provisions of RA No. 9184 and its 2016 revised IRR, including the Generic Procurement Manual, and associated issuances, constitute the primary source for the terms and conditions of the Contract, and thus, applicable in contract implementation. Herein clauses shall serve as the secondary source for the terms and conditions of the Contract.

This is without prejudice to Sections 74.1 and 74.2 of the 2016 revised IRR of RA No. 9184 allowing the GPPB to amend the IRR, which shall be applied to all procurement activities, the advertisement, posting, or invitation of which were issued after the effectivity of the said amendment.

2. **Sectional Completion of Works**

If sectional completion is specified in the **Special Conditions of Contract (SCC)**, references in the Conditions of Contract to the Works, the Completion Date, and the Intended Completion Date shall apply to any Section of the Works (other than references to the Completion Date and Intended Completion Date for the whole of the Works).

3. **Possession of Site**

3.1 The Procuring Entity shall give possession of all or parts of the Site to the Contractor based on the schedule of delivery indicated in the **SCC**, which corresponds to the execution of the Works. If the Contractor suffers delay or incurs cost from failure on the part of the Procuring Entity to give possession in accordance with the terms of this clause, the Procuring Entity's Representative shall give the Contractor a Contract Time Extension and certify such sum as fair to cover the cost incurred, which sum shall be paid by Procuring Entity.

3.2 If possession of a portion is not given by the above date, the Procuring Entity will be deemed to have delayed the start of the relevant activities. The resulting adjustments in contract time to address such delay may be addressed through contract extension provided under Annex "E" of the 2016 revised IRR of RA No. 9184.

4. **The Contractor's Obligations**

The Contractor shall employ the key personnel named in the Schedule of Key Personnel indicating their designation, in accordance with **ITB** Clause 10.3 and specified in the **BDS**, to carry out the supervision of the Works.

The Procuring Entity will approve any proposed replacement of key personnel only if their relevant qualifications and abilities are equal to or better than those of the personnel listed in the Schedule.

5. **Performance Security**

- 5.1. Within ten (10) calendar days from receipt of the Notice of Award from the Procuring Entity but in no case later than the signing of the contract by both parties, the successful Bidder shall furnish the performance security in any of the forms prescribed in Section 39 of the 2016 revised IRR.
- 5.2. The Contractor, by entering into the Contract with the Procuring Entity, acknowledges the right of the Procuring Entity to institute action pursuant to RA No. 3688 against any subcontractor be they an individual, firm, partnership, corporation, or association supplying the Contractor with labor, materials and/or equipment for the performance of this Contract.

6. Site Investigation Reports

The Contractor, in preparing the Bid, shall rely on any Site Investigation Reports referred to in the SCC supplemented by any information obtained by the Contractor.

7. Warranty

- 7.1. In case the Contractor fails to undertake the repair works under Section 62.2.2 of the 2016 revised IRR, the Procuring Entity shall forfeit its performance security, subject its property(ies) to attachment or garnishment proceedings, and perpetually disqualify it from participating in any public bidding. All payables of the GOP in his favor shall be offset to recover the costs.
- 7.2. The warranty against Structural Defects/Failures, except that occasioned-on force majeure, shall cover the period from the date of issuance of the Certificate of Final Acceptance by the Procuring Entity. Specific duration of the warranty is found in the SCC.

8. Liability of the Contractor

Subject to additional provisions, if any, set forth in the SCC, the Contractor's liability under this Contract shall be as provided by the laws of the Republic of the Philippines.

If the Contractor is a joint venture, all partners to the joint venture shall be jointly and severally liable to the Procuring Entity.

9. Termination for Other Causes

Contract termination shall be initiated in case it is determined *prima facie* by the Procuring Entity that the Contractor has engaged, before, or during the implementation of the contract, in unlawful deeds and behaviors relative to contract acquisition and implementation, such as, but not limited to corrupt, fraudulent, collusive, coercive, and obstructive practices as stated in ITB Clause 4.

10. Dayworks

Subject to the guidelines on Variation Order in Annex “E” of the 2016 revised IRR of RA No. 9184, and if applicable as indicated in the **SCC**, the Dayworks rates in the Contractor’s Bid shall be used for small additional amounts of work only when the Procuring Entity’s Representative has given written instructions in advance for additional work to be paid for in that way.

11. Program of Work

11.1. The Contractor shall submit to the Procuring Entity’s Representative for approval the said Program of Work showing the general methods, arrangements, order, and timing for all the activities in the Works. The submissions of the Program of Work are indicated in the **SCC**.

11.2. The Contractor shall submit to the Procuring Entity’s Representative for approval an updated Program of Work at intervals no longer than the period stated in the **SCC**. If the Contractor does not submit an updated Program of Work within this period, the Procuring Entity’s Representative may withhold the amount stated in the **SCC** from the next payment certificate and continue to withhold this amount until the next payment after the date on which the overdue Program of Work has been submitted.

12. Instructions, Inspections and Audits

The Contractor shall permit the GOP or the Procuring Entity to inspect the Contractor’s accounts and records relating to the performance of the Contractor and to have them audited by auditors of the GOP or the Procuring Entity, as may be required.

13. Advance Payment

The Procuring Entity shall, upon a written request of the Contractor which shall be submitted as a Contract document, make an advance payment to the Contractor in an amount not exceeding fifteen percent (15%) of the total contract price, to be made in lump sum, or at the most two installments according to a schedule specified in the **SCC**, subject to the requirements in Annex “E” of the 2016 revised IRR of RA No. 9184.

14. Progress Payments

The Contractor may submit a request for payment for Work accomplished. Such requests for payment shall be verified and certified by the Procuring Entity’s Representative/Project Engineer. Except as otherwise stipulated in the **SCC**, materials and equipment delivered on the site but not completely put in place shall not be included for payment.

15. Operating and Maintenance Manuals

15.1. If required, the Contractor will provide “as built” Drawings and/or operating and maintenance manuals as specified in the **SCC**.

- 15.2. If the Contractor does not provide the Drawings and/or manuals by the dates stated above, or they do not receive the Procuring Entity's Representative's approval, the Procuring Entity's Representative may withhold the amount stated in the SCC from payments due to the Contractor.

Section V. Special Conditions of Contract

Notes on the Special Conditions of Contract

Similar to the BDS, the clauses in this Section are intended to assist the Procuring Entity in providing contract-specific information in relation to corresponding clauses in the GCC found in Section IV.

The Special Conditions of Contract (SCC) complement the GCC, specifying contractual requirements linked to the special circumstances of the Procuring Entity, the Procuring Entity's country, the sector, and the Works procured. In preparing this Section, the following aspects should be checked:

- a. Information that complements provisions of the GCC must be incorporated.
- b. Amendments and/or supplements to provisions of the GCC as necessitated by the circumstances of the specific purchase, must also be incorporated.

However, no special condition which defeats or negates the general intent and purpose of the provisions of the GCC should be incorporated herein.

Special Conditions of Contract

GCC Clause	
2	<i>Not Applicable</i>
4.1	The Procuring Entity shall give possession of all parts of the Site to the Contractor upon receipt of Notice to Proceed.
6	The site investigation reports are: <i>None</i>
7.2	The warranty shall cover one (1) year from the date of issuance of the Certificate of Completion by the Procuring Entity
10	No further instructions
11.1	The Contractor shall submit the Program of Work to the Procuring Entity's Representative within 7 calendar days of delivery of the Notice of Award.
11.2	No further instruction
13	The amount of the advance payment shall not exceed 15% of the total contract price and schedule of payment.
14	Materials and equipment delivered on the site but not completely installed or put in place shall not be included for payment.
15.1	No further instructions
15.2	No further instructions

Section VI. Specifications

Notes on Specifications

A set of precise and clear specifications is a prerequisite for Bidders to respond realistically and competitively to the requirements of the Procuring Entity without qualifying or conditioning their Bids. In the context of international competitive bidding, the specifications must be drafted to permit the widest possible competition and, at the same time, present a clear statement of the required standards of workmanship, materials, and performance of the goods and services to be procured. Only if this is done will the objectives of economy, efficiency, and fairness in procurement be realized, responsiveness of Bids be ensured, and the subsequent task of bid evaluation facilitated. The specifications should require that all goods and materials to be incorporated in the Works be new, unused, of the most recent or current models, and incorporate all recent improvements in design and materials unless provided otherwise in the Contract.

Samples of specifications from previous similar projects are useful in this respect. The use of metric units is mandatory. Most specifications are normally written specially by the Procuring Entity or its representative to suit the Works at hand. There is no standard set of Specifications for universal application in all sectors in all regions, but there are established principles and practices, which are reflected in these PBDs.

There are considerable advantages in standardizing General Specifications for repetitive Works in recognized public sectors, such as highways, ports, railways, urban housing, irrigation, and water supply, in the same country or region where similar conditions prevail. The General Specifications should cover all classes of workmanship, materials, and equipment commonly involved in construction, although not necessarily to be used in a particular Works Contract. Deletions or addenda should then adapt the General Specifications to the particular Works.

Care must be taken in drafting specifications to ensure that they are not restrictive. In the specification of standards for goods, materials, and workmanship, recognized international standards should be used as much as possible. Where other particular standards are used, whether national standards or other standards, the specifications should state that goods, materials, and workmanship that meet other authoritative standards, and which ensure substantially equal or higher quality than the standards mentioned, will also be acceptable. The following clause may be inserted in the SCC.

Sample Clause: Equivalency of Standards and Codes

Wherever reference is made in the Contract to specific standards and codes to be met by the goods and materials to be furnished, and work performed or tested, the provisions of the latest current edition or revision of the relevant standards and codes in effect shall apply, unless otherwise expressly stated in the Contract. Where such standards and codes are national, or relate to a particular country or region, other authoritative standards that ensure a substantially equal or higher quality than the standards and codes specified will be accepted

subject to the Procuring Entity's Representative's prior review and written consent. Differences between the standards specified and the proposed alternative standards shall be fully described in writing by the Contractor and submitted to the Procuring Entity's Representative at least twenty-eight (28) days prior to the date when the Contractor desires the Procuring Entity's Representative's consent. In the event the Procuring Entity's Representative determines that such proposed deviations do not ensure substantially equal or higher quality, the Contractor shall comply with the standards specified in the documents.

These notes are intended only as information for the Procuring Entity or the person drafting the Bidding Documents. They should not be included in the final Bidding Documents.



NAME : REFURBISHMENT OF BUILDING (GMP/HACCP FACILITY)

LOCATION: DAVAO DEL SUR STATE COLEGE CAMPUS

SCOPE OF WORK

OTHER GENERAL REQUIREMENT

- Secure occupancy/building permits and other clearances.
- Submit signed and sealed plans. (9 copies)
- Site clearing and preparation.
- Install project billboards.
- Mobilization/Demobilization.
- Install temporary fencing/cordon/barrier.
- Submit signed and sealed as built plans. (9 copies)

CONSTRUCTION SAFETY AND HEALTH

- Ensure compliance with DOLE criteria for construction safety and health.
- Ensure that all workers to always wear PPEs. (Safety helmets, shoes, gloves, vest, and harness).

EARTHWORKS

- Removal of existing structures and obstruction.
- Structural Excavation (footing, footing tie beam, wall footings, column, slab on fill and stairs). (Refer to plan)
- Install batter boards and scaffoldings.
- Embankment. (Refer to plan)
- Gravel fill. (Refer to plan)

PLAIN AND REINFORCED CONCRETE WORK

- Cutting and bending of deformed bars for footings, wall footing, columns, and slab on fill. (Refer to plan)
- Fabricate column, footing tie beam and footing forms.
- Install deformed bar reinforcements on footings, footing tie beams, columns, and slab on fill.
- Concrete pouring on footings, columns, and slab on fill. (Structural Concrete: 20.7MPa Compressive Strength at 28 days)





TERMITE CONTROL WORKS

- Apply soil poisoning to building area.

MASONRY WORKS

- Cutting and bending deformed bars for concrete hollow blocks.
- Laying of concrete hollow blocks (non load bearing).
- Cement Plastering works.

FABRICATED MATERIALS AND HARDWARE

- Install awning type windows and fixed type (reflective glass) on powder coated aluminum frames.
- Install Kiln dried wooden panel doors with lever type doorknob on stainless steel jambs. **(Refer to plan)**
- Install tempered single leaf glass door with transom complete with hardware and accessories

FINISHING WORKS

- Install scaffolding for ceiling works.
- 4.5mm thick fiber cement board for canopy and parapet.
- Install metal ceiling framings e.g., wall angle, double metal furring, carrying channel.
- Plaster all concrete hollow blocks uniformly and without bumps. As to size refer to the plan.
- Install 60x60cm Unglazed Tile **(Refer to Plan)**
- Install Aluminum Tile Trim on doors and windows openings.
- Install Aluminum Step Nosing on all steps.
- Use Tile Adhesive as binder.
- Use Tile Grout (same color of tiles) for sealing of all connections/joints.

PAINTING WORKS

- Apply primer for all steel e.g., purlins, rectangular tube, angle bar, base plate, flat bar, plain round bar.
- Apply concrete neutralizer on all concrete surfaces.
- Apply concrete primer on all fiber cement board walling and fascia frame.
- Apply cast to hide surface imperfections and hair line cracks minimum of three (3) coats.
- Apply minimum of two (2) coats of topcoat elastomeric paint.
- Apply jointing compound and perforated tape for gypsum boards.
- Apply skim coat (white powder).
- Apply industrial finish paint.





- Apply a clear topcoat.
- Apply paint on all wooden doors and steel doorjamb.
- Fill all imperfections, knots, cracks and apply paint on all wooden doors and door jamb.

ROOF FRAMING AND ROOFING WORKS

- Fabricate, install, and apply primer: minimum of 2 coats for all steel components as shown on the plan and details.
- Install pre-painted LONG SPAN rib type roofing sheets. **(Refer to plan)**
- Install pre-painted pre-molded G.I. gutter.
- Apply roofs sealant whenever necessary.

STRUCTURAL STEEL WORKS

- Structural steel works. **(Refer to plan)**

PLUMBING WORKS

- Install all plumbing and waterline roughing-ins. **(Refer to plan)**
- Install all plumbing fixtures like water closet, urinal, lavatory, bidet, and floor drains and all items shown on the plan and details.

ELECTRICAL WORKS

- Install all electrical roughing –in and wirings. **(Refer to Electrical Plan)**
- Install all lightings, switches, convenience outlets, provisions and panel boards with circuit breakers. **(Refer to Electrical Plan)**

Prepared by:

ENGR. CARLOS ANDRIAN S. VILLANUEVA
 PPDME STAFF

Checked/ Reviewed by:

ENGR. CLARA A. ACEBES
 PPDME DIRECTOR

Recommending Approval:

LUCIANO D. NARIBOG JR., DBA
 VP FOR ADMIN AND FINANCE

Approved by:

AUZIE E. FUENTES, Ph.D.
 COLLEGE PRESIDENT

Section VII. Drawings

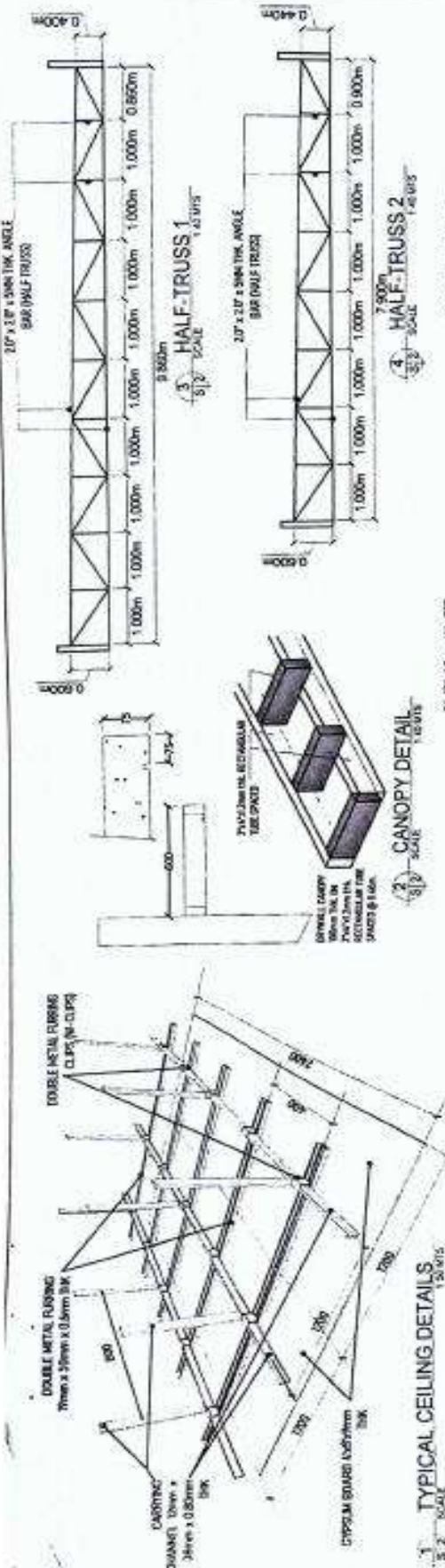

1 TYPICAL CEILING DETAILS
SCALE: 1/20

DESIGNATION	P1	C1	REB
	FOOTING TO F.O.L.	100x100x10	100x100x10
SECTION	700W x 200MM	W8x12	W6x9
VERT. BARS	6-19M2		
COLUMN TIES	1-10M2, 20-20M1, 4-10M2, 4-15M1 (REST @ 25MM O.C.)		

SCHEDULE OF FOOTING

FOOTING MARK	FOOTING DIMENSIONS (mm)		REINFORCEMENT			
	LENGTH (mm)	WIDTH (mm)	THICKNESS (mm)	FOUNDRY DEPTH (mm)	BOTTOM	TOP
F-1	1000	1000	300	1200	4-19M2 DRB & 4-19M2 DRB	4-19M2

NOTE:
 1. CONCRETE COMPRESSIVE STRENGTH = $f_c = 20.7 \text{ MPa}$ (3,000 PSI)
 2. STEEL REINFORCEMENT YIELD STRENGTH = $f_y = 275 \text{ MPa}$ (40)
 3. CONCRETE COMPRESSIVE STRENGTH = $f_c = 20.7 \text{ MPa}$ (3,000 PSI)
 4. STEEL REINFORCEMENT YIELD STRENGTH = $f_y = 415 \text{ MPa}$ (60)

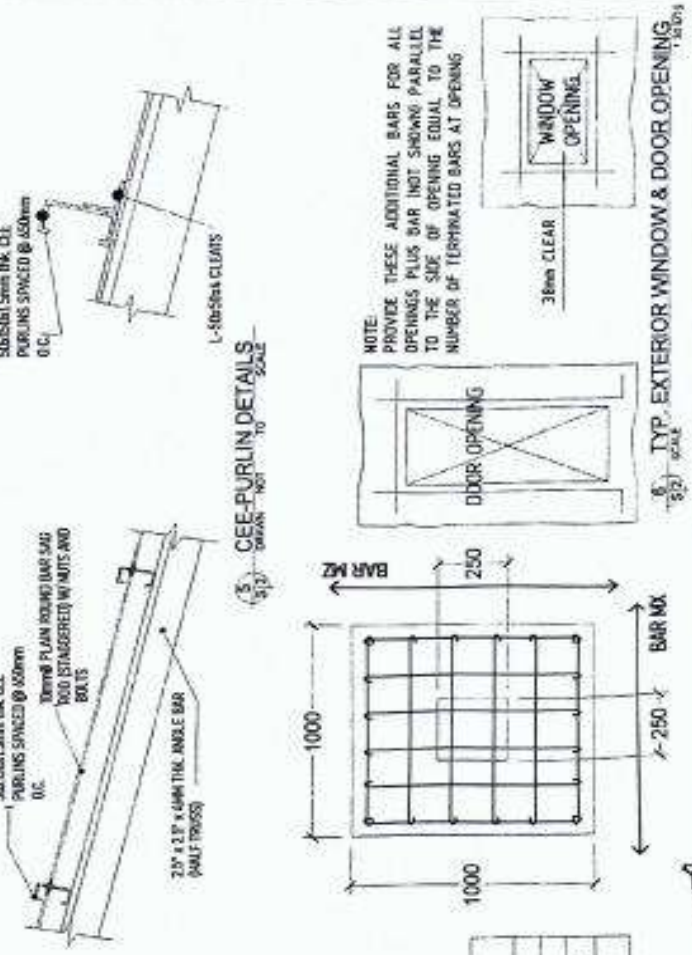

PROJECT TITLE: REINFORCEMENT OF BUILDING (GMP/HACCP FACILITY)
 LOCATION: SHAW-DAVEY 300 SOUTH COLLEGE CAMPUS, BIRD MOUNT, DISTRICT OF COLUMBIA, DC

PROPOSER: ENGR. DANIEL S. JORDAN, P.E.
 ENGR. CHRISTOPHER J. COOPER, P.E.

DESIGNER: ENGR. DANIEL S. JORDAN, P.E.
 ENGR. CHRISTOPHER J. COOPER, P.E.

DATE: 02-19-23

SCALE: AS SHOWN

PROJECT NO.: 23-0119

DATE: 02-19-23

PROJECT TITLE: REINFORCEMENT OF BUILDING (GMP/HACCP FACILITY)

PROJECT NO.: 23-0119

DATE: 02-19-23

ISOMETRIC VIEW
SCALE 1:100

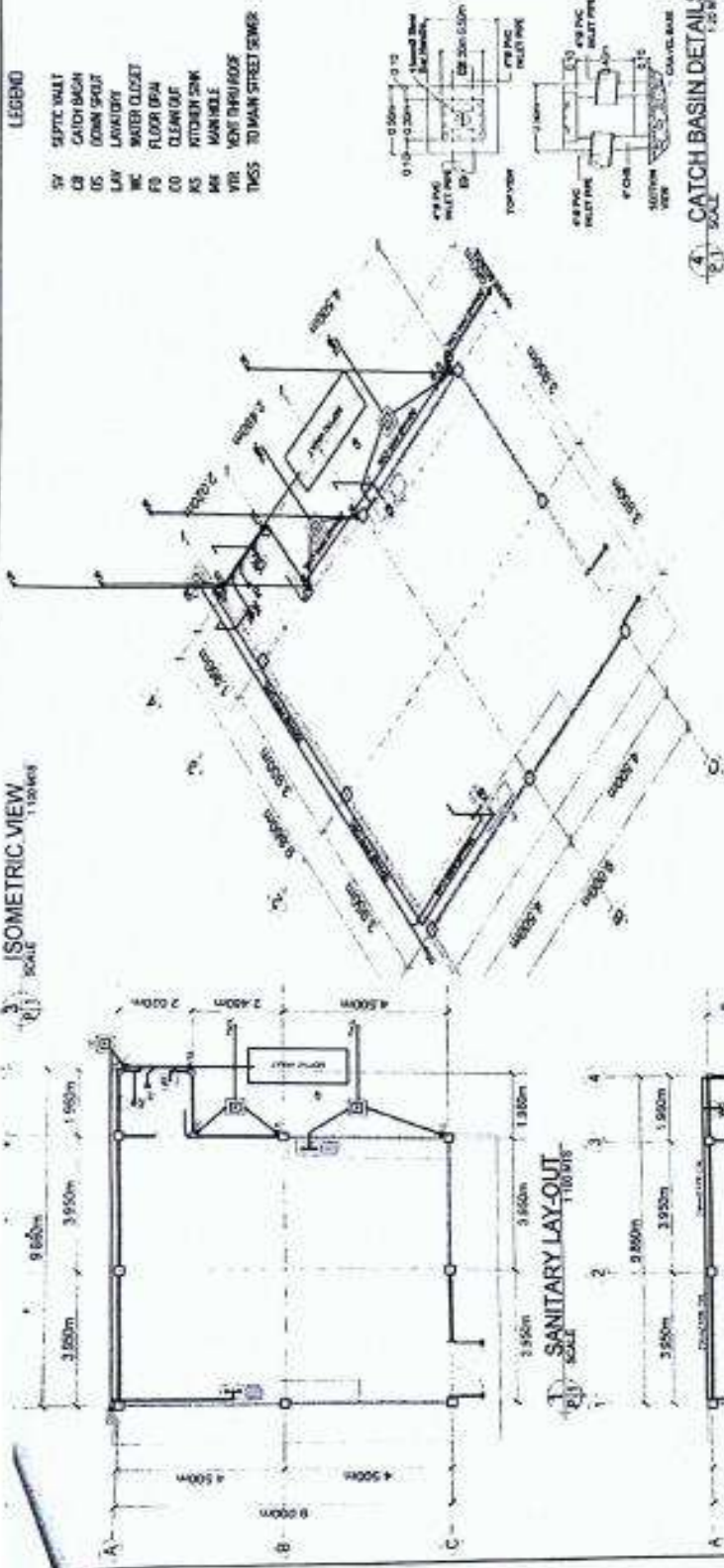

A. GENERAL CONDITIONS
THE WORKS EXERCISED UNDER THIS PROJECT SHALL INCLUDE ALL MATERIALS, LABOR AND EQUIPMENT NECESSARY FOR THE COMPLETION OF THE BUILDING AS SHOWN ON THE DRAWING AND AS SPECIFIED HEREIN AFTER ALL WORKS SHALL BE DONE UNDER THE DIRECT SUPERVISION OF A LICENSED PLUMBER SPECIFIED AND OF THE METHODS AS PROVIDED BY THE NATIONAL PLUMBING CODE OF THE PHILIPPINES.

B. DRAWING AND SPECIFICATIONS
THE DRAWINGS AND SPECIFICATIONS SHALL BE CONSIDERED COORDINATIVE, ANYTHING NOT SHOWN ON THE PLANS BUT SPECIFIED SHALL BE PART OF THE WORK.

C. ALTERATION OF PLANS AND CHANGE OF MATERIALS
NO ALTERATION ON THE PLAN AND CHANGE OF MATERIALS SHALL BE MADE WITHOUT FIRST CONSULTING THE ENGINEER OR ARCHITECT. NO CHANGE, ADDITION AND/OR DELETION SHALL BE MADE WITHOUT THE WRITTEN CONSENT OF THE ENGINEER OR ARCHITECT.

D. PLUMBING NOTES
ALL PLUMBING WORKS INCLUDED HEREIN SHALL BE EXECUTED ACCORDING TO THE REQUIREMENTS OF THE NATIONAL PLUMBING CODE AND THE RULES AND REGULATIONS OF THE LOCAL GOVERNMENT. COORDINATE THE DRAWING WITH OTHER RELATED DRAWINGS AND SPECIFICATIONS. THE ENGINEER SHALL BE NOTIFIED IMMEDIATELY OF ANY DISCREPANCY FOUND THEREIN. PIPES SHALL BE WITH PROOF APPROVAL OF THE ARCHITECT AND ENGINEER. PROPOSED SANITARY UTILITIES SHALL CONFORM TO THE ACTUAL LOCATION (DEPTH, AND INVERT ELEVATION) OF ALL EXISTING PIPES AND STRUCTURES AS VERIFIED BY THE CONTRACTOR. MINIMUM SLOPE FOR SEWER AND DRAIN LINES SHALL BE 2% UNLESS OTHERWISE INDICATED. USE 4" PVC PIPES FOR DWNS, FLOOR DRAINS, AND VENTILATION. USE 2" PVC PIPES FOR MAIN LINES AND WATER CLOSETS. PROVIDE AN AIR CHAMBER OF AT LEAST 100mm AT EVERY WATER SUPPLY BRANCH TO FLOOR OR MAIN VENT STACKS AND DROBT VENTS SHALL BE UPVC PIPE SERIES 100R BY "MELTON" HIGH IMPACT.

- LEGEND**
- SV SEPTIC VAULT
 - CB CATCH BASIN
 - DS DOWN SPOUT
 - LW LAUNDRY
 - WC WATER CLOSET
 - FD FLOOR DRAIN
 - CO CLEAN OUT
 - KS KITCHEN SINK
 - MB MANKIBLE
 - VR VENT THRU ROOF
 - THSS TO MAIN STREET SEWER

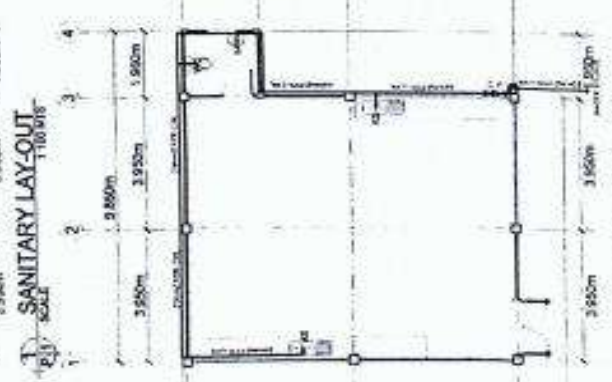
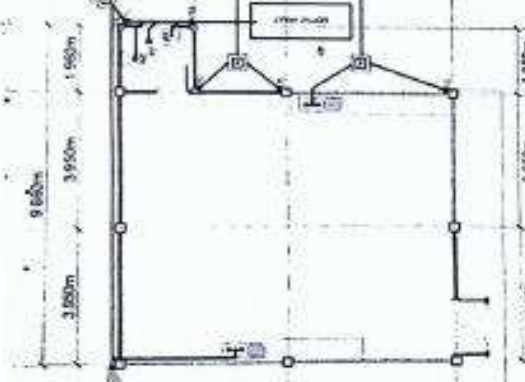
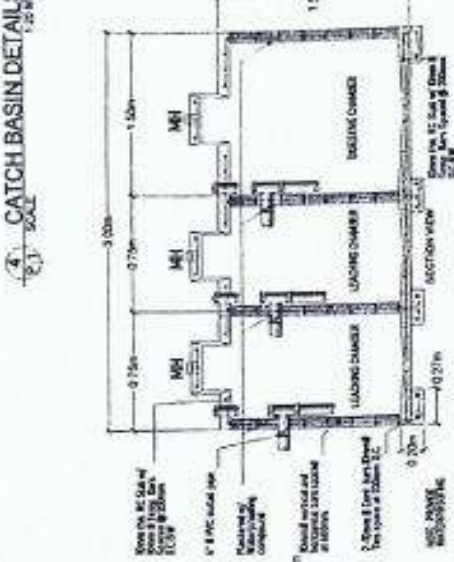
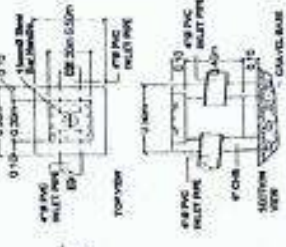

PROJECT TITLE	REPAIRMENT OF BUILDING (GAR/PACCT FACILITY) LOCATION: PANDOC BARBERS COLLEGE CAMPUS, BAY	DATE	12/14/23
DESIGNER	ENGR. EMANUEL S. BERNARDO ALDOBA REGISTERED PROFESSIONAL ARCHITECT	DATE OF PROJECT	12/14/23
APPROVED BY	ENGR. CELIA A. ACEDOS REGISTERED ARCHITECT	DATE OF APPROVAL	12/14/23
SPECIFICATIONS	AS PROVIDED	DATE	12/14/23

ELECTRICAL NOTES AND SPECIFICATIONS:

- ALL ELECTRICAL WORKS SHALL COMPLY IN ACCORDANCE WITH THESE PLANS AND SPECIFICATIONS, THE APPLICABLE PROVISIONS OF THE LATEST EDITION OF THE PHILIPPINE ELECTRICAL CODE (PEC) 1 & 2, THE RULES AND REGULATIONS OF THE LOCAL ENFORCING AUTHORITIES AND THE LOCAL POWER COMPANY.
- ALL ELECTRICAL WORKS SHALL BE DONE UNDER THE IMMEDIATE SUPERVISION OF A DAILY LICENSED AND REGISTERED ELECTRICAL PRACTITIONER.
- THE ELECTRICAL SERVICE POWER SHALL BE SINGLE PHASE, 208V, 200 VAC AND 60 HERTZ.
- ALL WIRES SHALL BE COPPER AND THE NONPLASTIC INSULATED TYPE THAT UNLESS OTHERWISE INDICATED IN THIS PLAN, THE MINIMUM SIZE OF WIRE FOR POWER AND LIGHTING CIRCUIT HOMERUN SHALL BE 2.0 mm² AND INSULATED FOR 600 VOLTS. THE SMALLEST RACEWAY SHALL BE 15 mm² TRADE NOMINAL.
- ALL OUTLETS SHALL BE GALVANIZED GAUGE NO. 18 TEEL-TYPE WITH FACTORY KNOCK-OUTS.
- ALL MATERIALS TO BE USED SHALL BE BRAND NEW AND APPROVED-TYPE FOR PARTICULAR LOCATION AND PURPOSE OF USAGE.
- GROUNDING SYSTEM SHALL BE PROVIDED TO ALL LIGHTING AND POWER CIRCUIT AS PER PHILIPPINE ELECTRICAL CODE (PEC) REQUIREMENTS.
- MOUNTING HEIGHTS FROM FINISH FLOOR LEVEL SHALL BE AS FOLLOWS:
 - LIGHTING SWITCHES 1.37 meters above finish floor line
 - CONVENIENCE OUTLETS 0.30 meters above finish floor line
 - PANELBOARD 1.80 meters above finish floor line
 - KILOWATTMETER 1.50 meters above finish floor line

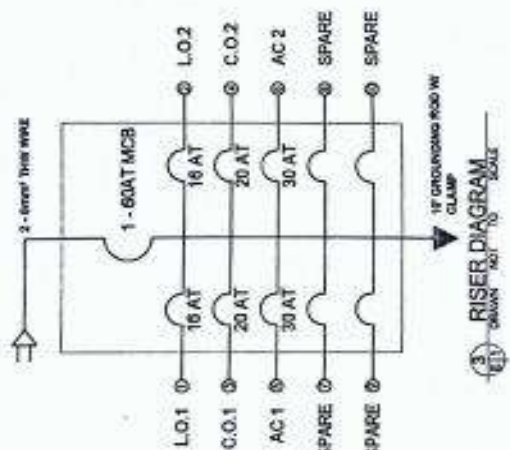

1" UNDESIGNED 300 WF CLAMP
RISER DIAGRAM
 3- CORE THREE WIRE LINE

ELECTRICAL LEGEND:

- Lighting Outlet
- Convenience Outlet
- AC Convenience Outlet
- Circuit Homerun (as indicated)
- Panelboard
- Circuit Breaker (as indicated)
- Kilowatt-hour Meter
- Service Entrance
- Grounding System
- Switch Line
- Power Line
- S1 One Gang LED Illuminated Switch
- S2 Two Gang LED Illuminated Switch
- S3M Two Gang LED Illuminated Switch
- SCF Two Gang LED Illuminated Switch
- B. Emergency Light
- Wall Mounted Lamp

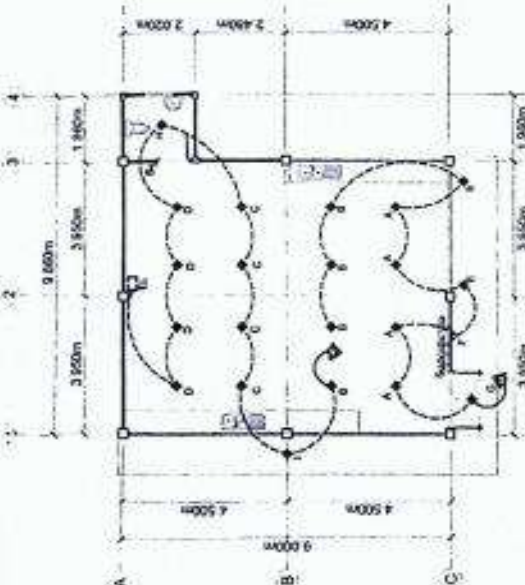

1 LIGHTING LAY-OUT
 SCALE: 1/32

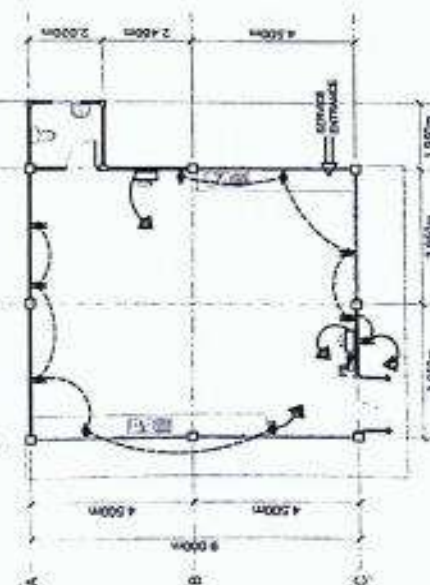

2 POWER LAY-OUT
 SCALE: 1/32

CIRCUIT #	DESCRIPTION	# OF OUTLETS	WATTS	TOTAL WATTS	VOLTAGE	CURRENT	CIRCUIT PROTECTION	CABLE SIZE
1	L.O. 1	11	100	1100	220	5.00	15AT	3.5mm ² THHN
2	L.O. 2	11	100	1100	220	5.00	15AT	3.5mm ² THHN
3	C.O. 1	5	180	900	220	4.09	20AT	3.5mm ² THHN
4	C.O. 2	5	180	900	220	4.09	20AT	3.5mm ² THHN
5	AC 1	1	2600	2600	220	11.36	30AT	3.5mm ² THHN
6	AC 2	1	2600	2600	220	11.36	30AT	3.5mm ² THHN
7	SPARE		2000	2000	220	9.09	---	---
8	SPARE		2000	2000	220	9.09	---	---
9	SPARE		2000	2000	220	9.09	---	---
10	SPARE		2000	2000	220	9.09	---	---
			13500	13500		77.28	150AT	5.5mm ² THW WIRE

1 - (4-10) 1/2" x 2 1/4"
 - (7) 25 x 30 (8) - (1) 30 x 40 (3)
 - (8) 100 x (2) 84
 - (4) 44

USE 90C THW
 USE 60 AT MAIN CIRCUIT BREAKER, 3P

4 SCHEDULE OF LOADS

SCHOOL LOGO	PROJECT TITLE	PREPARED BY	CHECKED BY	APPROVED BY	DATE	SHEET NO.
	REPAIRMENT OF BUILDING (COMPUTER FACILITY) LOCATION: BRNO DE LA ROSA STREET, CALABANG CITY, PANGASINAN	ENGR. EMMANUEL B. ALONZA 12-16-17	ENGR. JAMES C. UICLES 13-16-17	ENGR. CLARA A. ACERES 13-16-17	13-16-17	19
		ENGR. EMMANUEL B. ALONZA 20-02-2018	ENGR. JAMES C. UICLES 19-15-18	ENGR. CLARA A. ACERES 19-15-18	ENGR. JAMES C. UICLES 19-15-18	19-15-18

Section VIII. Bill of Quantities

Notes on the Bill of Quantities

Objectives

The objectives of the Bill of Quantities are:

- a. to provide sufficient information on the quantities of Works to be performed to enable Bids to be prepared efficiently and accurately; and
- b. when a Contract has been entered into, to provide a priced Bill of Quantities for use in the periodic valuation of Works executed.

In order to attain these objectives, Works should be itemized in the Bill of Quantities in sufficient detail to distinguish between the different classes of Works, or between Works of the same nature carried out in different locations or in other circumstances which may give rise to different considerations of cost. Consistent with these requirements, the layout and content of the Bill of Quantities should be as simple and brief as possible.

Daywork Schedule

A Daywork Schedule should be included only if the probability of unforeseen work, outside the items included in the Bill of Quantities, is high. To facilitate checking by the Entity of the realism of rates quoted by the Bidders, the Daywork Schedule should normally comprise the following:

- a. A list of the various classes of labor, materials, and Constructional Plant for which basic daywork rates or prices are to be inserted by the Bidder, together with a statement of the conditions under which the Contractor will be paid for work executed on a daywork basis.
- b. Nominal quantities for each item of Daywork, to be priced by each Bidder at Daywork rates as Bid. The rate to be entered by the Bidder against each basic Daywork item should include the Contractor's profit, overheads, supervision, and other charges.

Provisional Sums

A general provision for physical contingencies (quantity overruns) may be made by including a provisional sum in the Summary Bill of Quantities. Similarly, a contingency allowance for possible price increases should be provided as a provisional sum in the Summary Bill of Quantities. The inclusion of such provisional sums often facilitates budgetary approval by avoiding the need to request periodic supplementary approvals as the future need arises. Where such provisional sums or contingency allowances are used, the SCC should state the manner in which they will be used, and under whose authority (usually the Procuring Entity's Representative's).

The estimated cost of specialized work to be carried out, or of special goods to be supplied, by other contractors should be indicated in the relevant part of the Bill of Quantities as a particular provisional sum with an appropriate brief description. A separate procurement procedure is normally carried out by the Procuring Entity to select such specialized contractors. To provide an element of competition among the Bidders in respect of any facilities, amenities, attendance, etc., to be provided by the successful Bidder as prime Contractor for the use and convenience of the specialist contractors, each related provisional sum should be followed by an item in the Bill of Quantities inviting the Bidder to quote a sum for such amenities, facilities, attendance, etc.

Signature Box

A signature box shall be added at the bottom of each page of the Bill of Quantities where the authorized representative of the Bidder shall affix his signature. Failure of the authorized representative to sign each and every page of the Bill of Quantities shall be a cause for rejection of his bid.

These Notes for Preparing a Bill of Quantities are intended only as information for the Procuring Entity or the person drafting the Bidding Documents. They should not be included in the final documents.

Lot 1 - Supplies and Materials for the Refurbishment of Building (GMP/HACCP Facility)



Republic of the Philippines
DAVAO DEL SUR STATE COLLEGE
 Brgy. Matti, Digos City, Davao del Sur, Philippines 8002



Name of the Project: **Supplies and Materials for the Refurbishment of Building (GMP/HACCP Facility)**
 Location: **DAVAO DEL SUR STATE COLLEGE CAMPUS**
 Scope of Work: **As per Item Number**

BILL OF QUANTITIES					
ITEM NO.	ITEM DESCRIPTION	QUANTITY	UNIT	MATERIAL COST	AMOUNT
1	Embankment	1.00	lot.		
2	Concrete Works	1.00	lot.		
3	Masonry and Plastering Works	1.00	lot.		
4	Reinforcing Steel	1.00	lot.		
5	Door and Window	1.00	lot.		
6	Carpentry Works	1.00	lot.		
7	Welded Works	1.00	lot.		
8	Tile Works	1.00	lot.		
9	Plumbing Works	1.00	lot.		
10	Septic Vault	1.00	lot.		
11	Roofing Works	1.00	lot.		
12	Painting Works	1.00	lot.		
13	Electrical Works	1.00	lot.		
TOTAL MATERIAL COST					-

Prepared by:	Checked and Reviewed by:	End User Approval:	Recommending Approval:	Approved by:
<u>ENGR. CARLOS ANDRIAN S. VILLANUEVA</u> PPMDE STAFF	<u>ENGR. CLARA A. ACEBES</u> PPMDE DIRECTOR	<u>GRACIELA L. CABALLERO, Ph.D.</u> PROJECT LEADER	<u>LUCIANO D. NASIBUG JR., DBA</u> VP FOR ADMIN AND FINANCE	<u>AUGIE E. FUENTES, Ph.D.</u> COLLEGE PRESIDENT

 (+63) 939924-0793
  op@dssc.edu.ph
  www www.dssc.edu.ph

Lot 2 - Labor Costs for the Refurbishment of Building (GMP/HACCP Facility)



Name of the Project: Labor Costs for the Refurbishment of Building (GMP/HACCP Facility)
 Location: DAVAO DEL SUR STATE COLLEGE CAMPUS
 Scope of Work: As per Item Number

BILL OF QUANTITIES					
ITEM NO.	ITEM DESCRIPTION	QUANTITY	UNIT	LABOR COST	AMOUNT
1	Demolition	1.00	lot.		
2	Excavation/Clearing Works	1.00	lot.		
3	Embankment	1.00	lot.		
4	Concrete Work	1.00	lot.		
5	Masonry and Plastering Works	1.00	lot.		
6	Reinforcing Steel	1.00	lot.		
7	Door and Window	1.00	lot.		
8	Carpentry Works	1.00	lot.		
9	Welded Metal	1.00	lot.		
10	Tileworks	1.00	lot.		
11	Plumbing Works	1.00	lot.		
12	Septic Vault	1.00	lot.		
13	Roofing Works	1.00	lot.		
14	Painting Works	1.00	lot.		
15	Electrical Works	1.00	lot.		
TOTAL LABOR COST					-

Prepared by:	Checked and Reviewed by:	End User Approval:	Recommending Approval:	Approved by:
<u>ENGR. CARLOS ANDRIAN S. VILLANUEVA</u> PPDME STAFF	<u>ENGR. CLARA A. ACERES</u> PPDME DIRECTOR	<u>GRACIELA L. CABALLERO, Ph.D.</u> PROJECT LEADER	<u>LUCIANO D. NASIBUG JR., DBA</u> VP FOR ADMIN AND FINANCE	<u>AUGIE E. FUENTES, Ph.D.</u> COLLEGE PRESIDENT



Section IX. Checklist of Technical and Financial Documents

Notes on the Checklist of Technical and Financial Documents

The prescribed documents in the checklist are mandatory to be submitted in the Bid, but shall be subject to the following:

- a. GPPB Resolution No. 09-2020 on the efficient procurement measures during a State of Calamity or other similar issuances that shall allow the use of alternate documents in lieu of the mandated requirements; or
- b. any subsequent GPPB issuances adjusting the documentary requirements after the effectivity of the adoption of the PBDs.

The BAC shall be checking the submitted documents of each Bidder against this checklist to ascertain if they are all present, using a non-discretionary “pass/fail” criterion pursuant to Section 30 of the 2016 revised IRR of RA No. 9184.

Checklist of Technical and Financial Documents

I. TECHNICAL COMPONENT ENVELOPE

Class "A" Documents

Legal Documents

- (a) Valid PhilGEPS Registration Certificate (Platinum Membership) (all pages) in accordance with Section 8.5.2 of the IRR;

Technical Documents

- (b) Statement of the prospective bidder of all its ongoing government and private contracts, including contracts awarded but not yet started, if any, whether similar or not similar in nature and complexity to the contract to be bid; **and**
- (c) Statement of the bidder's Single Largest Completed Contract (SLCC) similar to the contract to be bid, except under conditions provided under the rules; **and**
- (d) Special PCAB License in case of Joint Ventures **and** registration for the type and cost of the contract to be bid; **and**
- (e) Original copy of Bid Security. If in the form of a Surety Bond, submit also a certification issued by the Insurance Commission **or** original copy of Notarized Bid Securing Declaration; **and**
- (f) Project Requirements, which shall include the following:
- a. Organizational chart for the contract to be bid;
 - b. List of contractor's key personnel (*e.g.*, Project Manager, Project Engineers, Materials Engineers, and Foremen), to be assigned to the contract to be bid, with their complete qualification and experience data;
 - c. List of contractor's major equipment units, which are owned, leased, and/or under purchase agreements, supported by proof of ownership or certification of availability of equipment from the equipment lessor/vendor for the duration of the project, as the case may be; **and**
- (g) Original duly signed Omnibus Sworn Statement (OSS) **and** if applicable, Original Notarized Secretary's Certificate in case of a corporation, partnership, or cooperative; or Original Special Power of Attorney of all members of the joint venture giving full power and authority to its officer to sign the OSS and do acts to represent the Bidder.

Financial Documents

- (h) The prospective bidder's computation of Net Financial Contracting Capacity (NFCC).

Class “B” Documents

- (i) If applicable, duly signed joint venture agreement (JVA) in accordance with RA No. 4566 and its IRR in case the joint venture is already in existence **or** duly notarized statements from all the potential joint venture partners stating that they will enter into and abide by the provisions of the JVA in the instance that the bid is successful.

II. FINANCIAL COMPONENT ENVELOPE

- (j) Original of duly signed and accomplished Financial Bid Form; **and**

Other documentary requirements under RA No. 9184

- (k) Original of duly signed Bid Prices in the Bill of Quantities; **and**
- (l) Duly accomplished Detailed Estimates Form, including a summary sheet indicating the unit prices of construction materials, labor rates, and equipment rentals used in coming up with the Bid; **and**
- (m) Cash Flow by Quarter.

